

General Description



- DA100 KNX-DALI Gateway operates as an interface device between KNX bus and DALI bus (According to DALI Standard-IEC 62386). DALI line power supply is integrated in the device.
- Maximum 64 DALI devices (e.g. electronic ballast, transformer, LED driver, ECK, sensor) can be connected to DALI output.
- Addressing and grouping of DALI devices is made via DALI commissioning tool PC software.
- DA100 enables to control 16 DALI groups and can store 64 different lighting scenes.
- Each group can be configured to operate with constant light level, corridor and sequence functions.
- DA100 can manage DALI ECK (emergency conversion kit) devices by means of downloading configured automatic test schedules, triggering tests and monitoring test results as well as other ECK fault conditions.
- DA100 utilizes DALI sensors* for internal corridor and constant light level control on DALI groups. It is also possible to transmit current presence statuses and measured brightness values of DALI sensors on KNX bus. Maximum 8 DALI sensors can be utilized on DALI bus.
- Fault statuses of DALI devices can be monitored by both device based or group based via different communication objects on the KNX.
- Creating of overlapping DALI groups is possible.

* Supported DALI sensor device: Tridonic - MSensor02, Art. No: 86459303

Technical Data

Type of protection	IP 20	EN 60529
Safety class	II	EN 61140
KNX supply⁽⁴⁾	Voltage Current consumption	21 - 30V DC, SELV < 10mA
Mains supply⁽⁶⁾	Voltage Power consumption Current consumption	85 - 300V AC @ 50-60Hz Max. 8W 100mA @ 85V AC
DALI supply⁽⁵⁾	Voltage Current	16V DC typical Max. 200mA
Connections	Screw terminals Max tightening torque KNX terminal	0,05 - 2,5mm ² solid wire 0,03 - 1,5mm ² stranded wire 0.5Nm Red - grey bus connect terminal
Output	Number of DALI devices Cable lengths	Max. 64 (include max. 8 sensor) 1.5 mm ² Max. 300 m 0.75 mm ² Max. 150 m 0.5 mm ² Max. 100 m
Installation	35mm mounting rail	EN 60715
Operating elements	Programming LED and button ^{(2) (3)} Green LED ⁽⁷⁾ Yellow LED ⁽⁸⁾ Red LED ⁽⁹⁾ Manual button ⁽¹⁰⁾ Test button ⁽¹¹⁾	Physical address localization KNX power OK Initialization active (fast blink) A DALI device fault present (slow blink) Mains power failure (constant on) Manual operation active Activate the manual test Switch-dim DALI output (on manual mode)
Temperature range	Ambient Storage	-5°C +45°C -25°C +55°C

	Transport	-25°C +70°C	
Humidity	Max. air humidity	95% no moisture condensation	
Dimensions	Width W in mm	70 x W x 91mm	
	Width W in units	69mm 4 modules (18mm modules)	
Weight		0.15 kg	
Box	Plastic, polycarbonate, colour grey		
CE	In accordance with the EMC guideline and low voltage directive		
Application program	Communications object count	Number of addresses (max)	Number of assignments (max)
	249	254	255

Connection Example

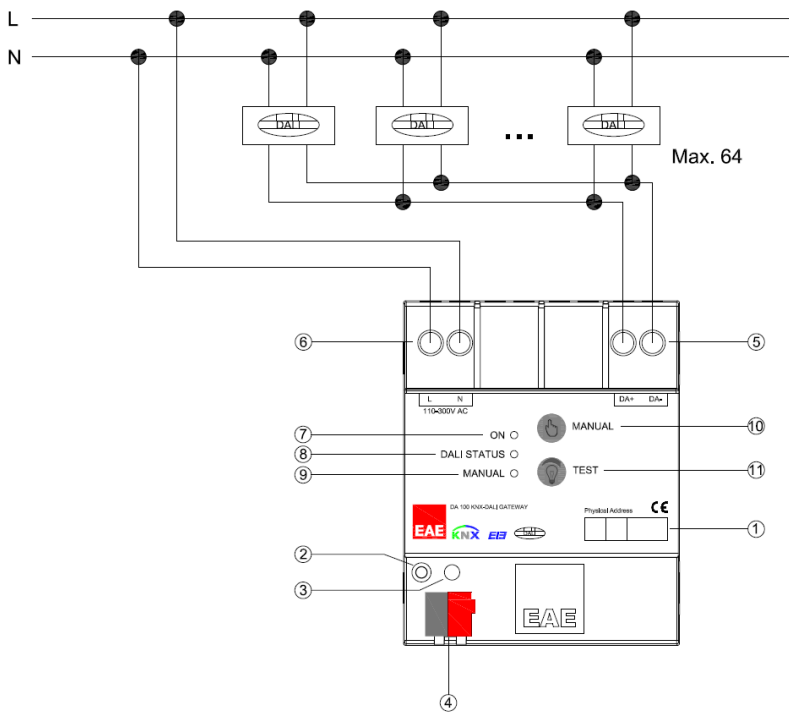

Scale Drawings

